

SWASH
60X50X84 h.

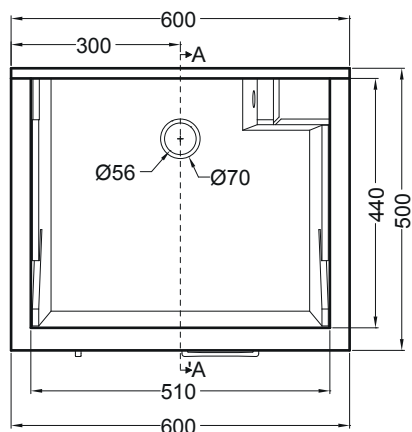

PIANTA

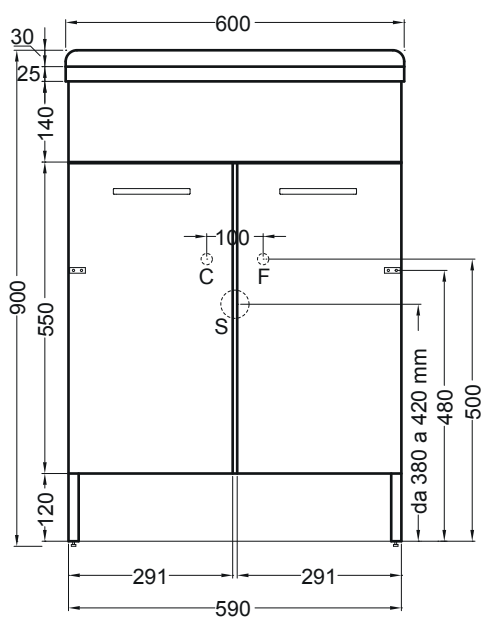

VISTA FRONTALE

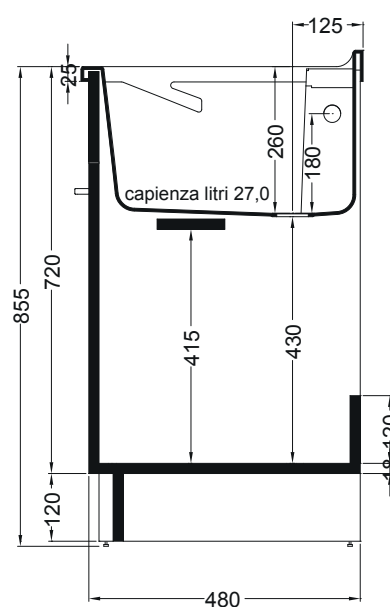

SEZIONE A-A'